

AM.5.VR... MODULAR PRESSURE REDUCING VALVES WITH RELIEVING - PILOT OPERATED CETOP 5

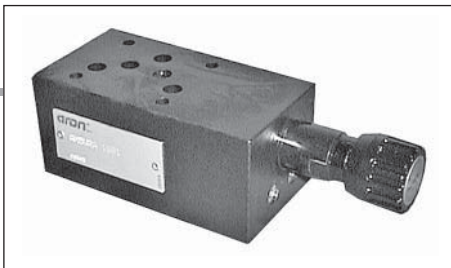

AM.5.VR...
CVR.20... BFP CARTRIDGE CATALOGUE
SCREWS AND STUDS CH. IV PAGE 36

These pressure reducing valves ensure a minimum pressure variation on the P or A port with changing flow rate up to 90 l/min.

Three spring types allow adjustment with the range 7 ÷ 250 bar. Manual adjustment is available by a grub screw or plastic knob.

The RELIEVING SYSTEM inside the valve AM.5.VR allows the passage from the setting pressure line to T line of the flow through the valve to avoid the increasing of pressure in the reduced-pressure line by diverting exceeding flow to reservoir.

A by pass module with check valve for free flow from A to AR port (see hydraulic symbol) is available.

Max. operating pressure	350 bar
Setting ranges:	spring 1 60 bar
	spring 2 120 bar
	spring 3 250 bar

Maximum allowed Δp pressure between the inlet and outlet pressure	150 bar
Max. flow	90 l/min
Draining on port T	0,5 ÷ 0,7 l/min
Hydraulic fluids	Mineral oils DIN 51524
Fluid viscosity	10 ÷ 500 mm ² /s
Fluid temperature	-25°C ÷ 75°C
Ambient temperature	-25°C ÷ 60°C
Max. contamination level	class 10 in accordance with NAS 1638 with filter $\beta_{25} \geq 75$
Weight	3,73 Kg
Weight by-pass version	6,56 Kg

ORDERING CODE

- AM** Modular valve
- 5** CETOP 5/NG10
- VR** Pilot operated pressure reducing valve with relieving
- *** Control on lines
P = Drain on T
A = Drain on T
D = Drain on B reduct pressure on A
- *** Drain connection
E = External (only for control on the P line)
I = Internal (Standard)
- B** Version with by-pass on line A only
Omit if not required
- *** Type of adjustment
M = Plastic knob
C = Grub screw
- *** Setting ranges
1 = max. 60 bar (**white spring**)
2 = max. 120 bar (**yellow spring**)
3 = max. 250 bar (**green spring**)
- **** 00 = No variant
V1 = Viton
- 1** Serial No.

HYDRAULIC SYMBOLS

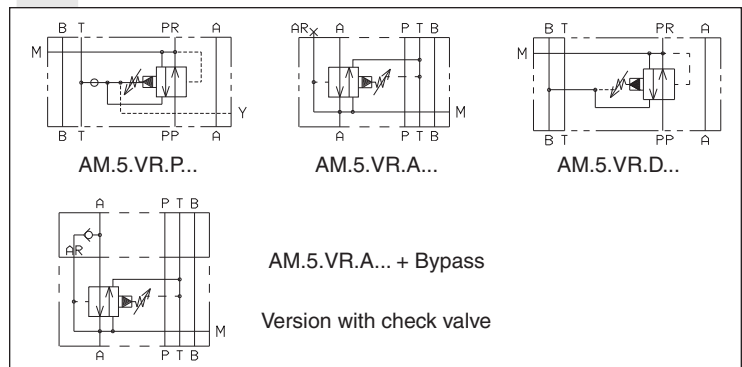

PRESSURE-FLOW RATE

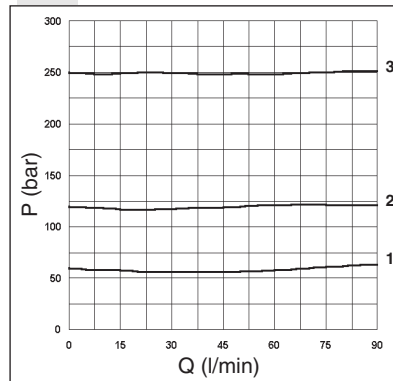

PRESSURE-FLOW OF RELIEVING

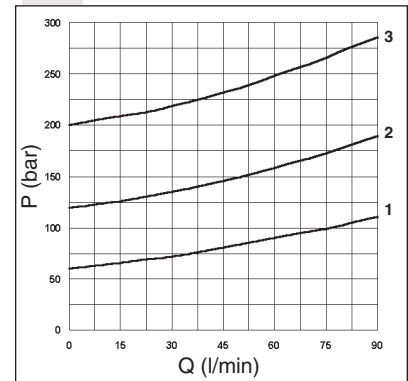

ΔP AM.5.VR... + BY-PASS

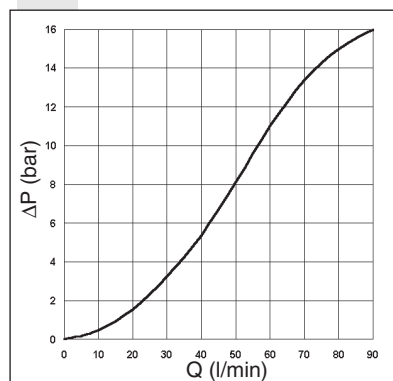

MINIMUM SETTING PRESSURE

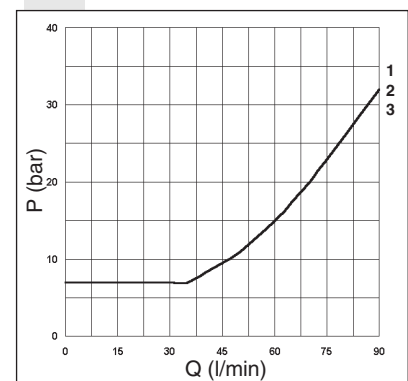

To change valves AM.5.VR.P... from internal to external drainage it is necessary:

- screw out the plug on the Y port
- screw out the plug T.C.E.I. M8x1 from the body
- screw in a screw S.T.E.I. M6
- rescrew the T.C.E.I. M8x1 plug on the body

NOTE: the external draining can be used as a piloting line (please, contact our Technical Service for other informations)

Curves n° 1 - 2 - 3 = setting ranges

The fluid used is a mineral oil with a viscosity of 46 mm²/s at 40°C. The tests have been carried out at a fluid temperature of 50°C.

OVERALL DIMENSIONS

AM.5.VR.P... / AM.5.VR.D...

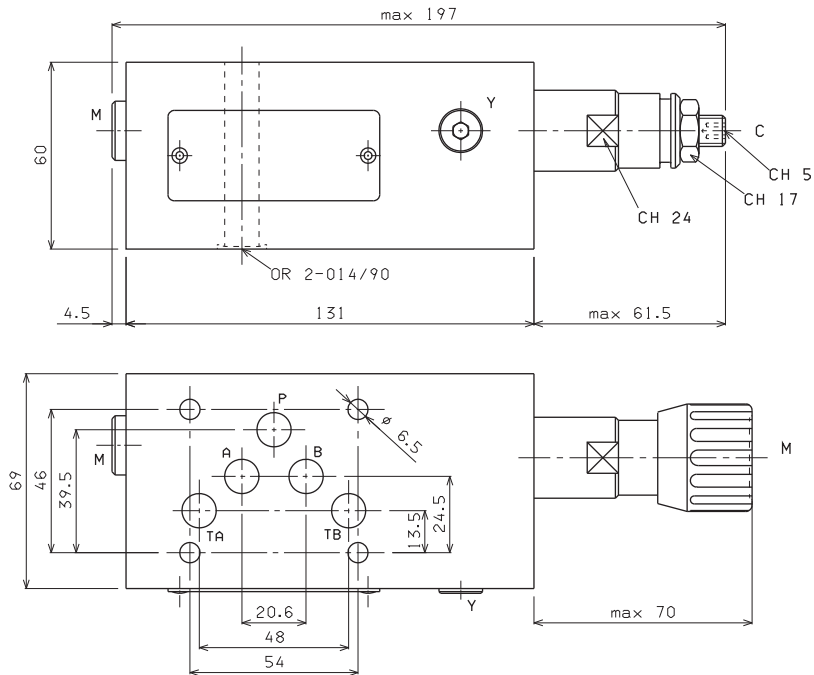

AM.5.VR.A... + BYPASS

(B) By-pass (optional)
Ordering code:
V89.46.0000
(if ordered separately)

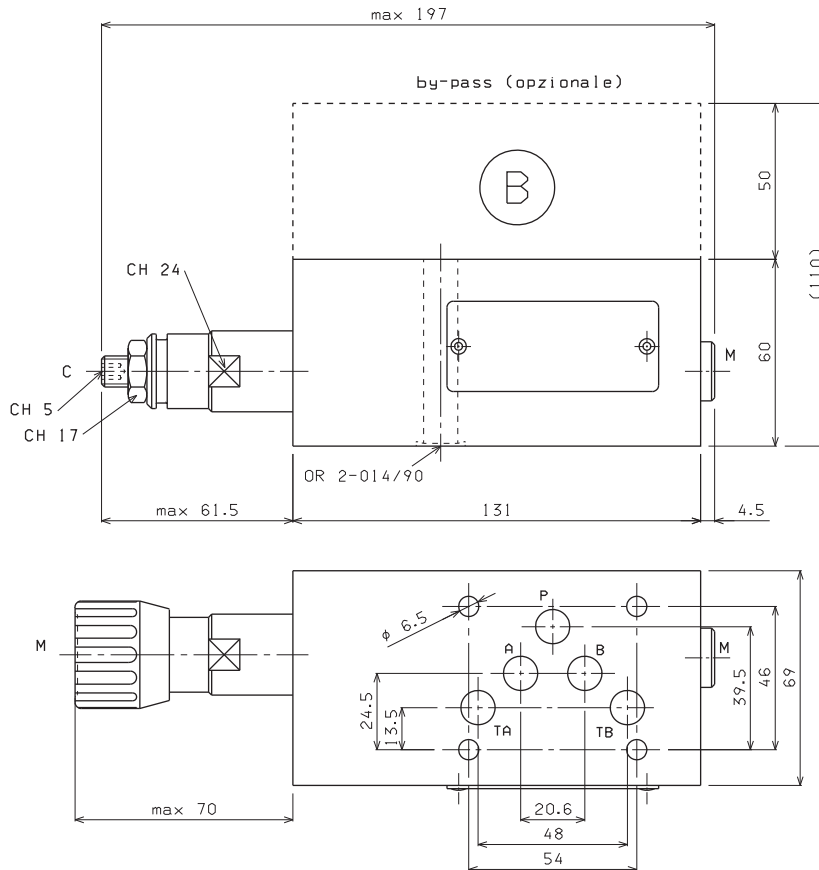

Type of adjustment

M Plastic knob

C Grub screw

Support plane specifications

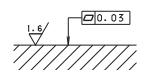

4